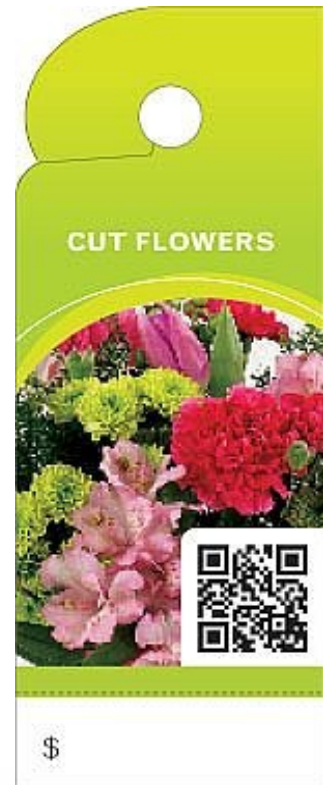
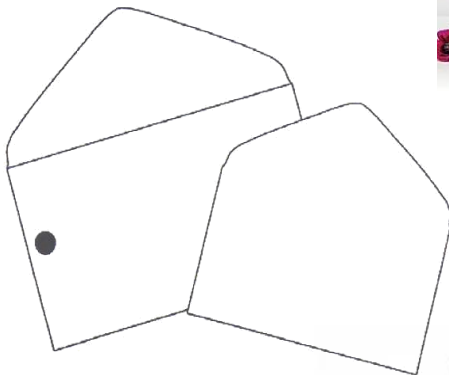

Fall River Florist Supply

Stationery

Two overlapping order forms. The top form is titled "Wedding Flowers" and includes sections for "Flowers", "Floral Centerpiece", and "Floral Arch". The bottom form is titled "Ceremony Seating" and includes a table for listing items, quantities, and prices, along with a section for "Ceremony Seating".

Stationery

Fall River's Item number will be **#87860**

Plus the 3 numbers on the card.

Pk / 50

Buy 10 @ **\$1.62** Pk Net / \$1.80 Pk

**NO
SENTIMENT**



Stationery

Fall River's Item number will be **#87860**
 Plus the 3 numbers on the card.
 Pk / 50

Buy 10 @ **\$1.62** Pk Net / \$1.80 Pk

**NO
 SENTIMENT**



GET WELL



Stationery

Fall River's Item number will be **#87860**

Plus the 3 numbers on the card.

Pk / 50

Buy 10 @ **\$1.62** Pk Net / \$1.80 Pk

BIRTHDAY



THINKING OF YOU



Stationery

Fall River's Item number will be **#87860**

Plus the 3 numbers on the card.

Pk / 50

SYMPATHY

Buy 10 @ **\$1.62** Pk Net / \$1.80 Pk

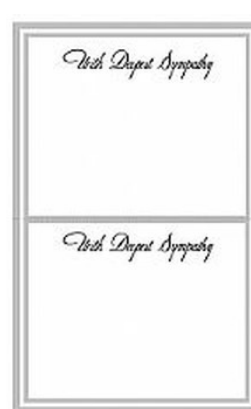
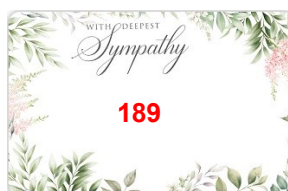
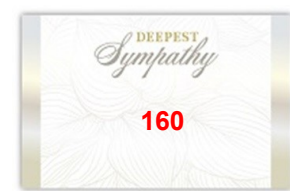
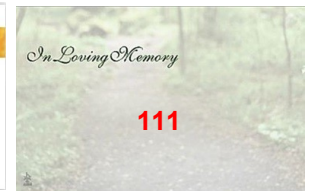
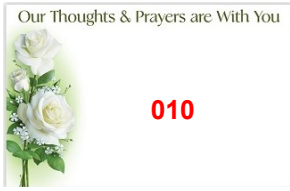

**Duplicate Card
With Deep Sympathy
#70537 Pk / 50
Buy 5 @ \$3.51 Pk Net /
\$3.90 Pk**

Stationery

Fall River's Item number will be **#87860**

Plus the 3 numbers on the card.

Pk / 50

Buy 10 @ **\$1.62** Pk Net / \$1.80 Pk

CONGRATULATIONS



ANNIVERSARY



BABY



Stationery

Fall River's Item number will be **#87860**

Plus the 3 numbers on the card.

Pk / 50

Buy 10 @ **\$1.62** Pk Net / \$1.80 Pk

BEST WISHES



GOOD LUCK

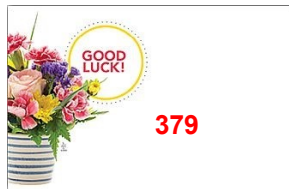

JUST BECAUSE



JUST FOR YOU

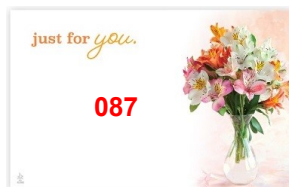

SORRY

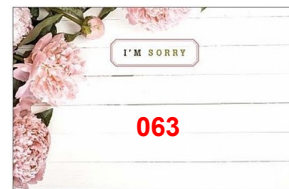

THANK YOU

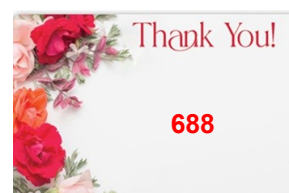
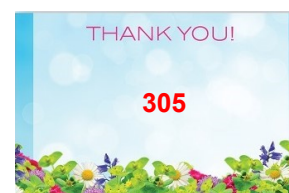

Stationery

Fall River's Item number will be **#87860**

Plus the 3 numbers on the card.

Pk / 50

Buy 10 @ **\$1.62** Pk Net / \$1.80 Pk

LOVE

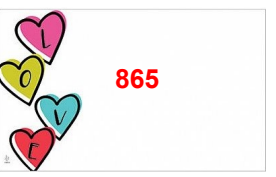
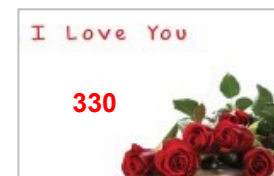
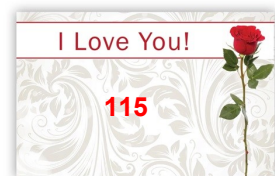
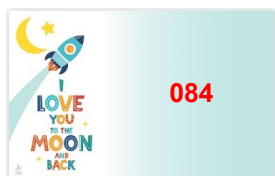
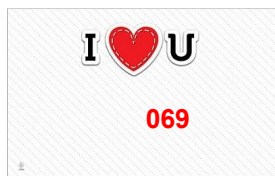

VALENTINE'S DAY

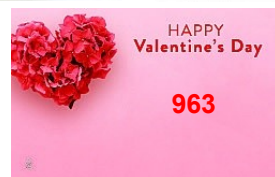
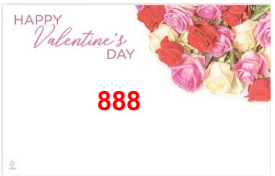
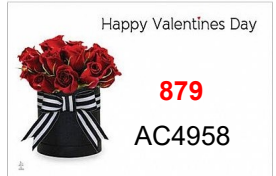
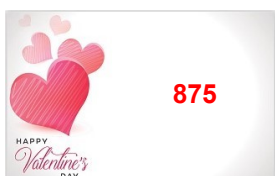
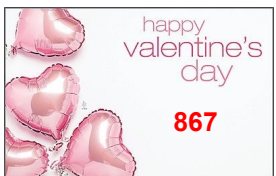
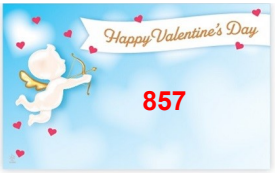
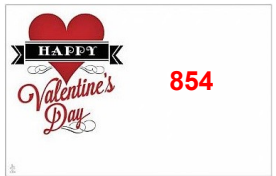
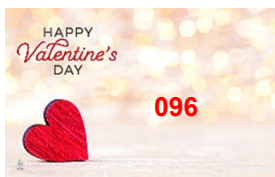

Stationery

Fall River's Item number will be **#87860**

Plus the 3 numbers on the card.

Pk / 50

Buy 10 @ **\$1.62** Pk Net / \$1.80 Pk

EASTER



ST. PATRICK'S DAY



MOTHER'S

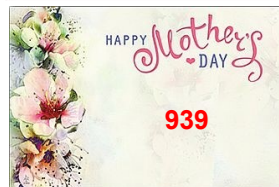
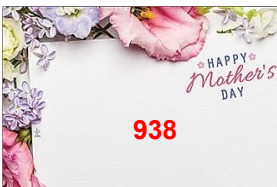

Administrative / Professional Week

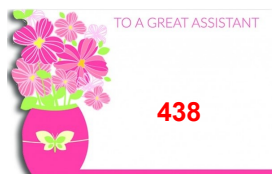

FATHER'S DAY



Stationery

Fall River's Item number will be **#87860**

Plus the 3 numbers on the card.

Pk / 50

Buy 10 @ **\$1.62** Pk Net / \$1.80 Pk

FALL OCCASIONS



Counter Top Card Rack
#71297 11"W x 10"D x 9 1/2"H
 Holds 500 Cards
\$47.95 Cs Net



Pen-O-Rack Plastic
#71296 16"L x 7"W x 3 1/2"H
 Holds 600 Cards
Cards Sold Separately
\$14.00 Cs Net

Stationery

HOLIDAY STATIONERY

Fall River's Item number will be **#87860**

Plus the 3 numbers on the card.

Pk / 50

Buy 10 @ **\$1.62** Pk Net / \$1.80 Pk

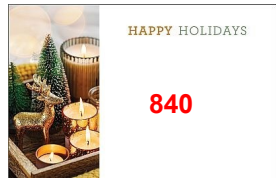
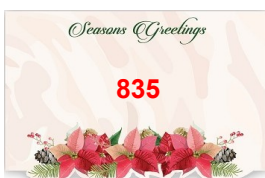

Stationery

Tell Tags

#87870 Pk / 100

Buy 5 @ \$4.05 Pk Net / \$4.50 Pk

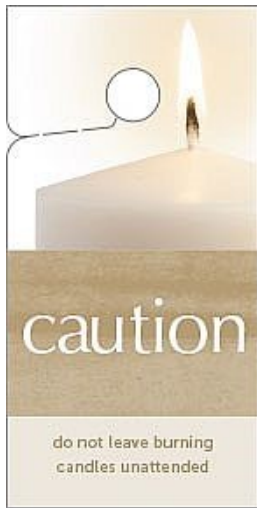

343



344



345

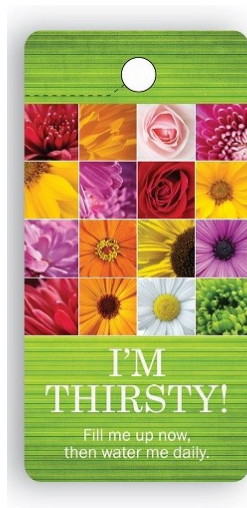

346



350



359

FLOWER ARRANGEMENT



360

GREEN PLANT



369

ROSE ARRANGEMENT

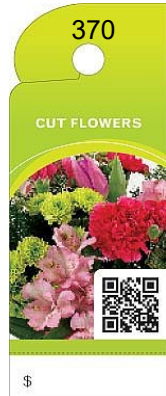

370

CUT FLOWERS

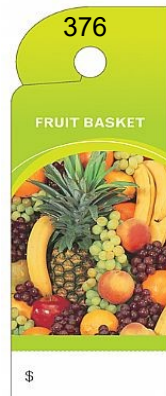

376

FRUIT BASKET



381

DISH GARDEN



Door Hanger

#87871 288 Pk / 100

Buy 5 @ \$4.95 Pk Net / \$5.50 Pk

Available in:

- 320 Blank
- 321 Dieffenbachia
- 322 Ficus
- 323 Flowering Plant
- 324 Christmas
- 325 Succulent
- 326 Terrarium
- 351 African Violet
- 352 Cyclamen
- 353 Easter Lily
- 354 Chrysanthemum
- 356 Hydrangea
- 357 Poinsettia
- 358 Azalea
- 359 Flower Arrangement
- 368 Kalanchoe

Care Tags

#87872 Pk / 100
Buy 5 @ \$4.95 Pk Net / \$5.50 Pk

- 360 Green Plant
- 362 Bulb Plant
- 369 Rose Arrangement
- 370 Cut Flowers
- 371 Fresh Cut Roses
- 374 Check Off
- 376 Fruit Basket
- 377 Rieger Begonia
- 381 Dish Garden
- 382 Guarantee
- 384 Spathiphyllum
- 386 Balloons
- 388 Bromeliad
- 389 Orchid
- 390 European Garden
- 397 Ivy
- 398 Pothos



Delivery Notice Door Hanger

#81864 006 Pk / 50
Buy 5 @ \$4.05 Pk Net / \$4.50 Pk

Stationery

Envelope #63 No Eyelet
#71248 Bx / 500
\$20.95 Bx Net

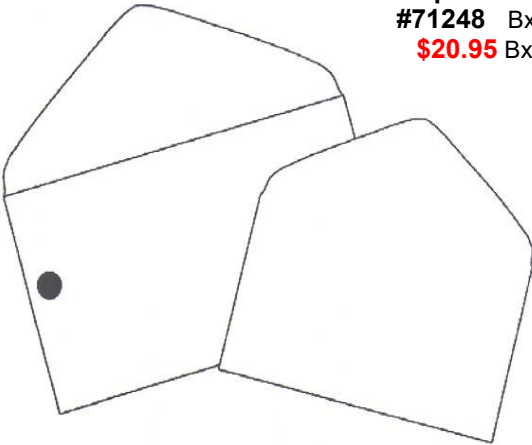

#63 Envelope w / Eyelet
#71245 Bx / 500
\$27.95 Bx Net



#56 Envelope w / Window
#71245 Bx / 500
\$24.50 Bx Net

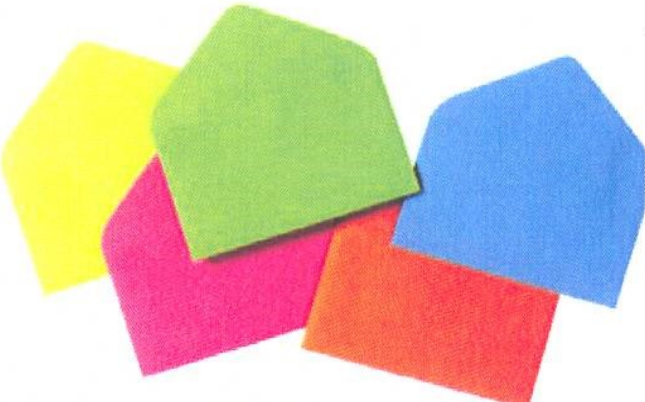

#63 Assorted Color Envelopes
#71254 099 4 1/2" x 2 1/2" Bx / 500
\$19.95 Bx Net



**Envelope #56
Rose Border**
#71240 Bx / 500
\$21.50 Bx Net



**Envelope #56
Rose Photo**
#71237 Bx / 500
\$21.50 Bx Net

Stationery

IF RECIPIENT IS NOT AT HOME
 • Leave Please Notice
 • Sign on all orders
 • Make notation on form where delivery was left
 • Never leave deliveries outside in cold or hot weather to prevent freezing or wilting

ROUTE & RECEIPT

ITEM GUIDE
 A - Arrangement
 F - Specialty Arrangement
 P - Plant or Planter
 C - Container
 CF - Cut Flowers
 D - Other

NAME _____ DATE _____
 MILEAGE OUT _____ IN _____
 TIME OUT _____ IN _____

No.	Qty	Name	Address	Remarks

Route & Receipt Form
#71287 Pk / 5 50 Sheets / Pad
 8 1/2" x 7"
\$12.95 Pk Net

DATE	A.M.	P.M.	CHARGE	C.O.D.	PAID

SEND TO _____

 DESCRIPTION PHONE

CARD _____

CHARGE TO _____

NAME CODE NO.

WIRE IN OUT PTD TF OTHER

FRANKS USA THE JOHN HENRY CO., LANSING, MI 48241 USA 811

#2 Regular Order Pad
#71272 100 Sheets / Pad
 4 1/4" x 7" Pk / 10
\$15.95 Pk Net

Deluxe Sales Ticket

#80007 3 Part Pk / 250
 5 1/2" x 8 1/2"
\$42.50 Pk Net

SOLD TO _____ OPERATIONS _____
 RECEIVED _____ SALES _____
 CUSTOMER PHONE NON-PHONE ORDERED BY _____
 CITY STATE ZIP CODE RECEIVED NO. _____
 ORDER # _____
 SALES PRICE _____ TAX _____
 NET TOTAL _____
 DELIVERY _____
 RELAY _____
 SEC _____
 GR TOTAL _____
 DELIVERY DATE _____
 SALES & ANALYSIS _____

DELIVER TO _____ DELIVERY TIME _____
 ADDRESS _____ CITY _____ STATE _____ ZIP CODE _____
 NAME (PRINT) _____ SPECIAL INSTRUCTIONS _____

Order Pad Regular #2

Customer Order

DATE	A.M.	P.M.	CHARGE	C.O.D.	PAID

SEND TO _____

 DESCRIPTION PHONE

CARD _____

CHARGE TO _____

NAME CODE NO.

WIRE IN OUT PTD TF OTHER

#71272 Pk / 10
\$15.95 Pk Net

#71273 Pk / 10
\$12.50 Pk Net

Teleflora Sales Ticket
#80004 3Pt Pk / 250
\$23.95 Bx Net

Wedding Order Form

#71278 50 Sheets / Pad
 8 1/2" x 14"
 Buy 5 @ **\$6.50** Ea Net / \$7.50 Ea

WEDDING ORDER FORM

DATE _____ TIME _____
 ADDRESS _____ CITY _____ STATE _____ ZIP CODE _____
 NAME (PRINT) _____ SPECIAL INSTRUCTIONS _____
 DELIVERY DATE _____ TIME _____

FLORIST'S NAME _____ PHONE _____
 ADDRESS _____ CITY _____ STATE _____ ZIP CODE _____

Deluxe Wedding Order Forms
#71284 50 Sheets / Pad
 11" x 17" Flat, Folds to 8 1/2" x 11"
 Buy 5 @ **\$6.30** Ea Net / \$7.00 Ea

Call **800-825-8252** Ext **239** or
 Visit us at **myfrfs.com**

Carbonless Wedding Order Form

#71281 25 2-Part Forms / Pad
 8 1/2" x 14"
 Buy 5 @ **\$6.50** Ea Net / \$7.00 Ea

CARBONLESS WEDDING ORDER FORM

DATE _____ TIME _____
 ADDRESS _____ CITY _____ STATE _____ ZIP CODE _____
 NAME (PRINT) _____ SPECIAL INSTRUCTIONS _____
 DELIVERY DATE _____ TIME _____

FLORIST'S NAME _____ PHONE _____
 ADDRESS _____ CITY _____ STATE _____ ZIP CODE _____

Wedding Order Form

#71278 50 Sheets / Pad
 8 1/2" x 14"
 Buy 5 @ **\$6.50** Ea Net / \$7.50 Ea

WEDDING ORDER FORM

DATE _____ TIME _____
 ADDRESS _____ CITY _____ STATE _____ ZIP CODE _____
 NAME (PRINT) _____ SPECIAL INSTRUCTIONS _____
 DELIVERY DATE _____ TIME _____

FLORIST'S NAME _____ PHONE _____
 ADDRESS _____ CITY _____ STATE _____ ZIP CODE _____